

A collage of four images related to aviation: a blue and white aircraft in flight, a green and blue aircraft on a tarmac, the FAdeA factory entrance sign, and a small red aircraft on a runway.

SUBGERENCIA DE INGENIERIA PROCESO DE DISEÑO Y DESARROLLO DE OBSOLESCENCIAS

The logo consists of a stylized blue 'F' shape followed by the text 'FAdeA' in a bold, blue, sans-serif font.

FAdeA

Fábrica Argentina de Aviones "Brig. San Martín" S.A.

PROCESOS DISEÑO Y DESARROLLO

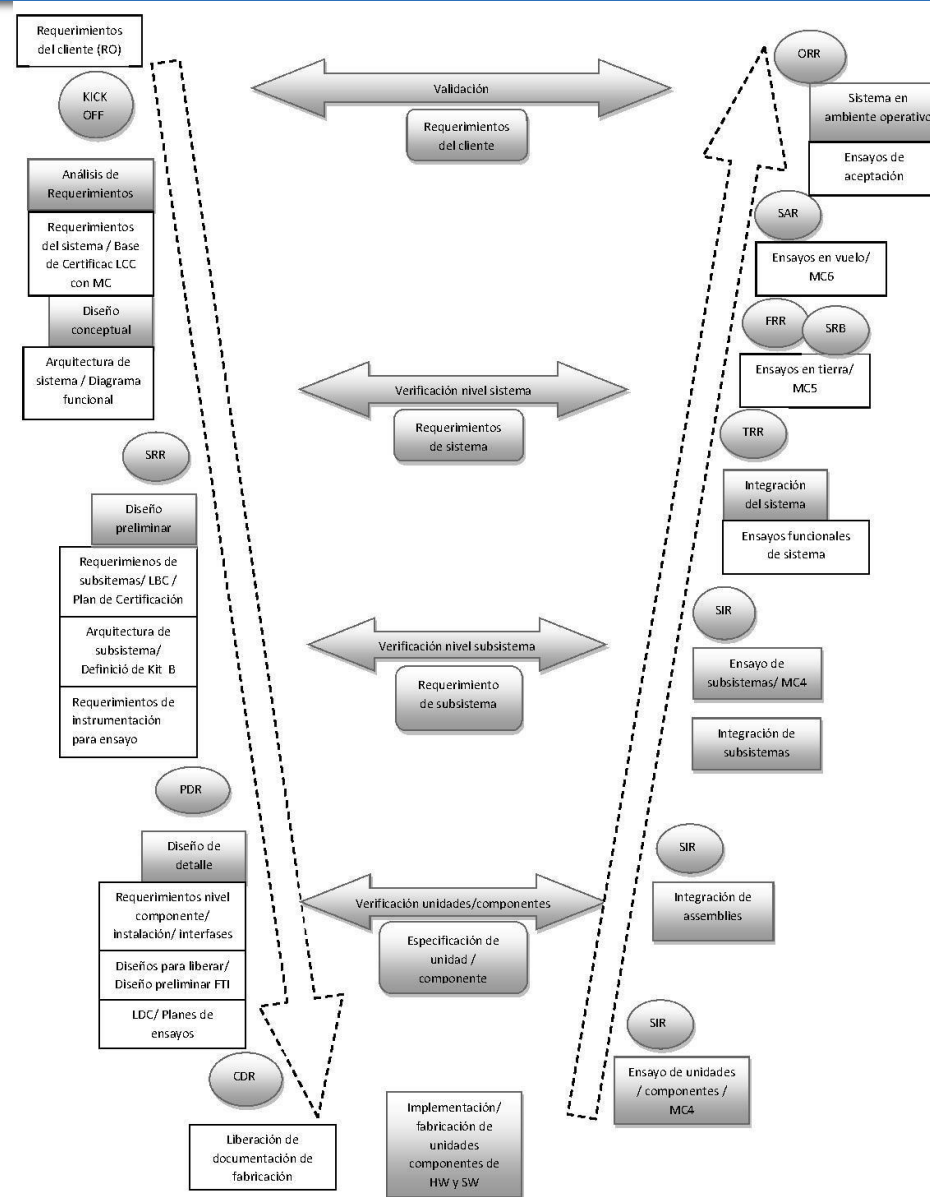

PROCESOS DISEÑO Y DESARROLLO OBSOLESCENCIAS.

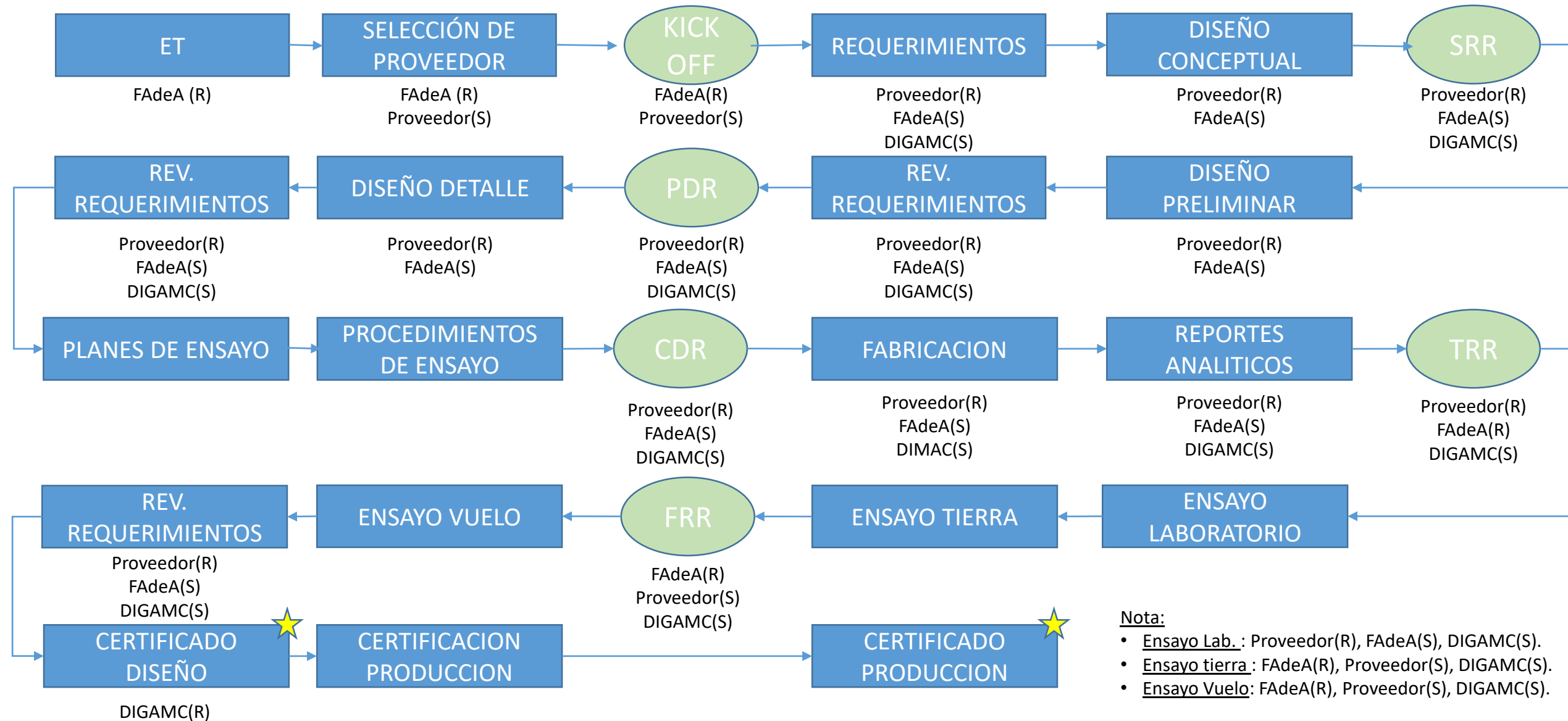

OBSOLESCENCIAS

- CAJA INDICACION CANTIDAD DE COMBUSTIBLE.







FAdeA

Fábrica Argentina de Aviones "Brig. San Martín" S. A.

ENGINEERING

TECHNICAL SPECIFICATION

Technical Spec Nr	ET/GING/004/19	Revision /
Title	TECHNICAL SPECIFICATION - FUEL QUANTITY SIGNAL AMPLIFIER FOR IA-63 PAMPA	
SdA	XQ - IA-63 PAMPA	
Program, Project or Subprogram	OBSOLESCENCIAS, SERVICIOS TECNICOS DE INGENIERIA	
Date	08 / 30 / 2019	
Issued by	Eng. Guillermo Brignone 83496	
Reviewed by	Eng. Diego Tinaro 82602 Eng. Diego Mercado 82689 Eng. Diego Carrasco 83184	  
Approved by	Eng. Carlos Ghirardelli 82337	

CONFIDENTIAL

Fábrica Argentina de Aviones S.A. - Av. Fuerza Aérea Argentina 5500 - X5010JMN - Córdoba - República Argentina



OBSOLESCENCIAS

- TRANSPARENCIAS DE CUPULA.

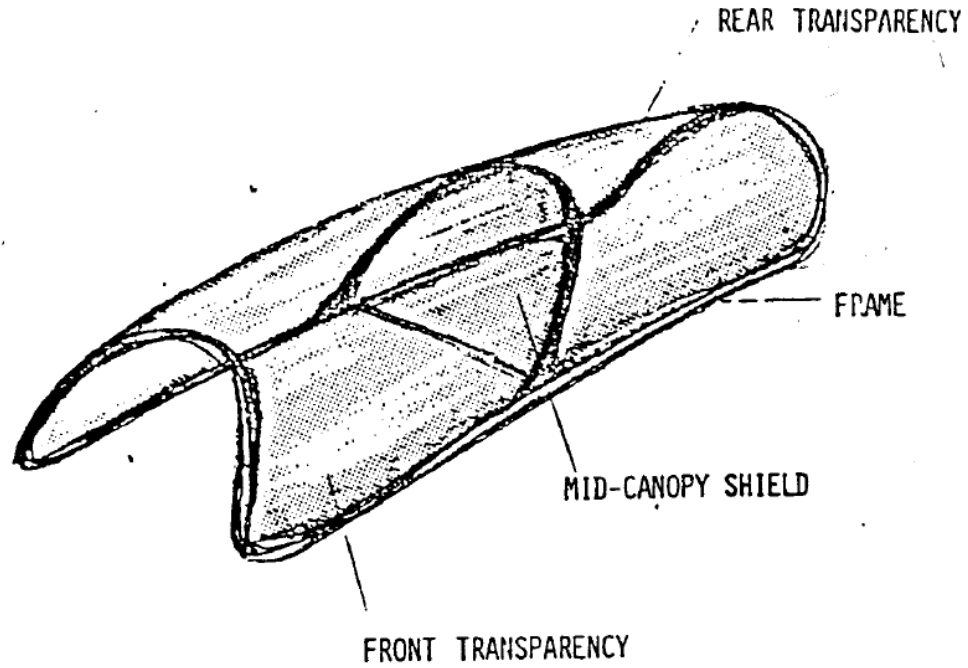

/A63/ DORNIER FAA	
EQUIPMENT SPECIFICATION	SPEC. NO. SL 63A--270510A01B
	DATE 02.09.82
	A.T.P. NO.
	PAGES 1-18
Name <u>CANOPY FRONT AND REAR TRANSPARENCIES</u>	
Manufacturer <u>FA. KOPPERSCHMIDT</u>	Code No. <u>582000</u>
Part. No. <u>63A--270510A01B</u>	Type _____
DORNIER <u>[Signature]</u> (Ersteller)	FMA <u>[Signature]</u>
<u>[Signature]</u> (GE) (RF)	<u>[Signature]</u>
<u>[Signature]</u> Projektleitung	<u>[Signature]</u>
- 1 -	
ISSUE	A B C



Especificacion

OBSOLESCENCIAS

- BURLETE INFLABLE DE CUPULA.

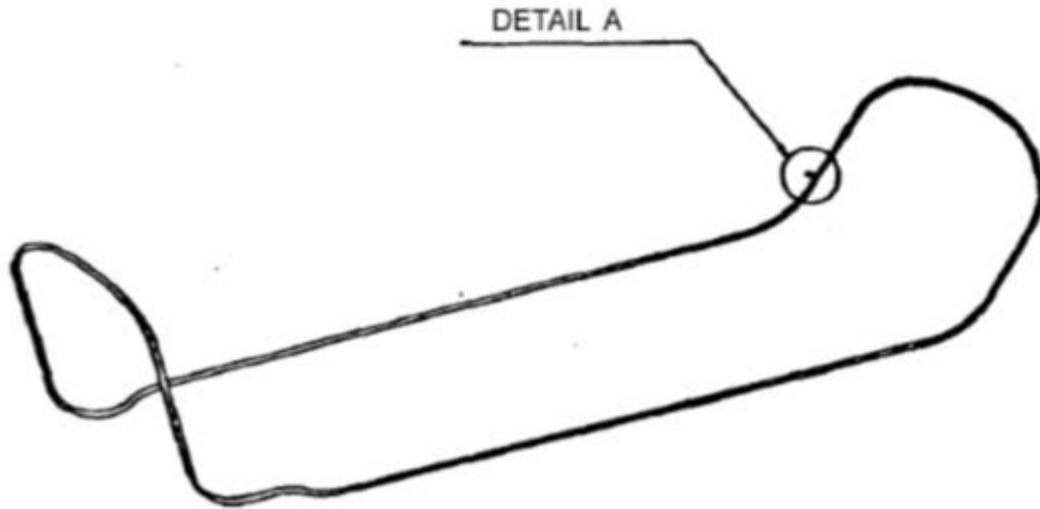

Fábrica Argentina de Aviones "Brig. San Martín" S. A.

ENGINEERING

TECHNICAL SPECIFICATION

Technical Spec Nr	ET/GING/001/18	Revision /
Title	CANOPY SEALING	
SdA	XQ - IA-63 PAMPA	
Program, Project or Subprogram	N/A	
Date	08 / 27 / 2018	

Issued by Fernando Rodríguez Almada
82397

Reviewed by Cristian Penizzotto
82655

Diego Carrasco
83184

Approved by Sebastian Serrudo
82618

CONFIDENTIAL

Fábrica Argentina de Aviones S.A. - Av. Fuerza Aérea Argentina 5500 - X5010JMN - Córdoba - República Argentina



Especificación

OBSOLESCENCIAS

- CAPACITORES DE COMBUSTIBLE.



/A63/ DORNIER FAA	
EQUIPMENT SPECIFICATION	SPEC. NO. ST. 63A--670 001 AQQB
	DATE 10.11.83
	A.T.P. NO.
	PAGES: 56
Name <u>FUEL QUANTITY GAUGING SYSTEM</u>	
Manufacturer <u>GULL</u>	Code No. According SYCO-LIST Page 4
Part. No. According SYCO-LIST Page 4	Type According SYCO-LIST Page 4
DORNIER	
<u>H. Krütt / Tillmann</u> (Ersteller) H. Krütt / Tillmann SA 20 / SA 30	FMA
<u>H. Fernandez</u> (QE) H. Fernandez - QE 20	<u>Sr. Benito</u>
<u>H. Rieck</u> Projektleitung H. Rieck - AP 50	<u>Sr. Corti</u>
ORIGINAL 30.08.84 - 13 09 84 L	
FAA	
ISSUE	A B



OBSOLESCENCIAS

- TANQUE DE COMBUSTIBLE FLEXIBLE

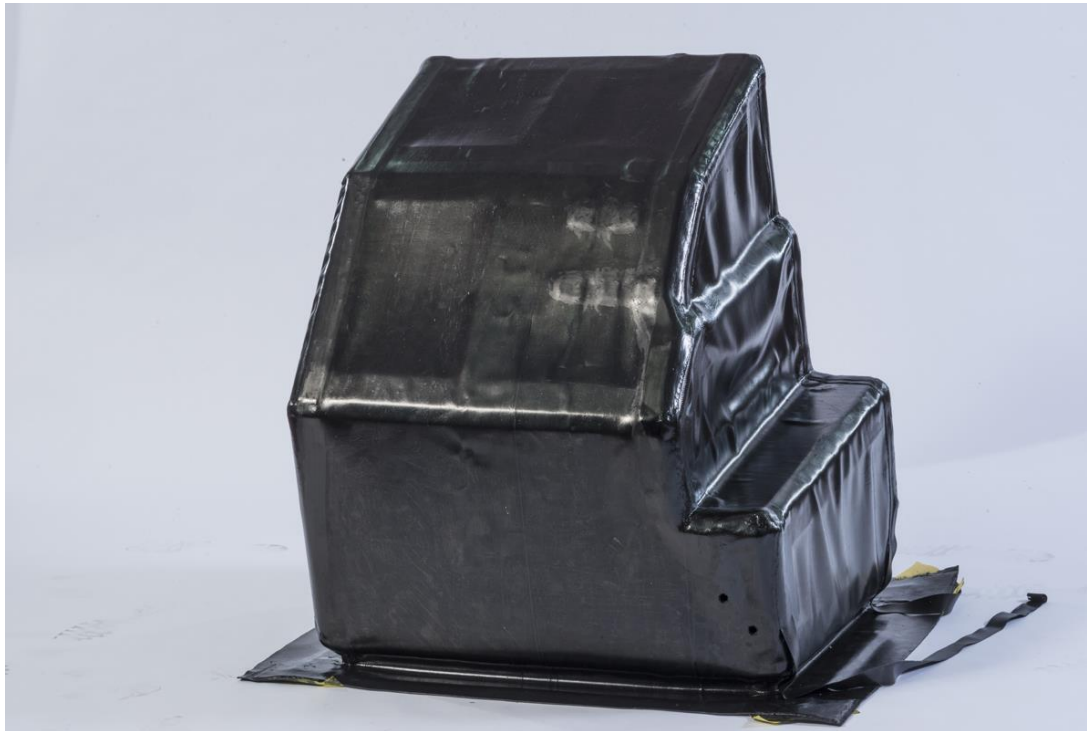

A63/ DORNIER FAA	
EQUIPMENT SPECIFICATION	SPEC. NO. SL 63A--672 001 A00B
	DATE 19.10.83
	A.T.P. NO.
	PAGES 19
Name <u>Flexible Fuselage Tank</u>	
Manufacturer <u>UNIROYAL</u>	Code No. <u>28 11 00</u>
Part. No. <u>EP-658-82</u>	Type _____
DORNIER FMA	
<u>H. Krütt</u> (Ersteller) H. Krütt - SA 20	<u>[Signature]</u> Sr. Benitez /
<u>J. Fernandez</u> (QE) H. Fernandez	<u>[Signature]</u> Sr. Garcia Sr. Muñoz
<u>Rieck</u> Projektleitung H. Rieck - AP 50	<u>[Signature]</u> Sr. Corti / VCom. Benza
19-12-83	
FAA 02.12.83 -1-	
ISSUE	A



OBSOLESCENCIAS

- BOTELLON DE O2 DE EMERGENCIA.



IA63/ DORNIER FAA

EQUIPMENT SPECIFICATION	SPEC. NO. SL 63A--723240A00C
	DATE 15.04.85
	A.T.P. NO.
	PAGE OF 11
Annex I	

Name Emergency Oxygen Bottle

35 11 10

Manufacturer Drägerwerk AG Code No. 35 12 10

Part. No. E 25 985 Type _____

DORNIER

Ehse
(Ersteller) Ehse

Kurbel
(QE)

Wawel
Projektleitung

ORIGINAL
23 4 86
FMA

[Signature]

[Signature]

01.86
FAA

Issue:

A	B	C	D						
---	---	---	---	--	--	--	--	--	--



Especificacion

OBSOLESCENCIAS

- DEPOSITO HIDRAULICO.

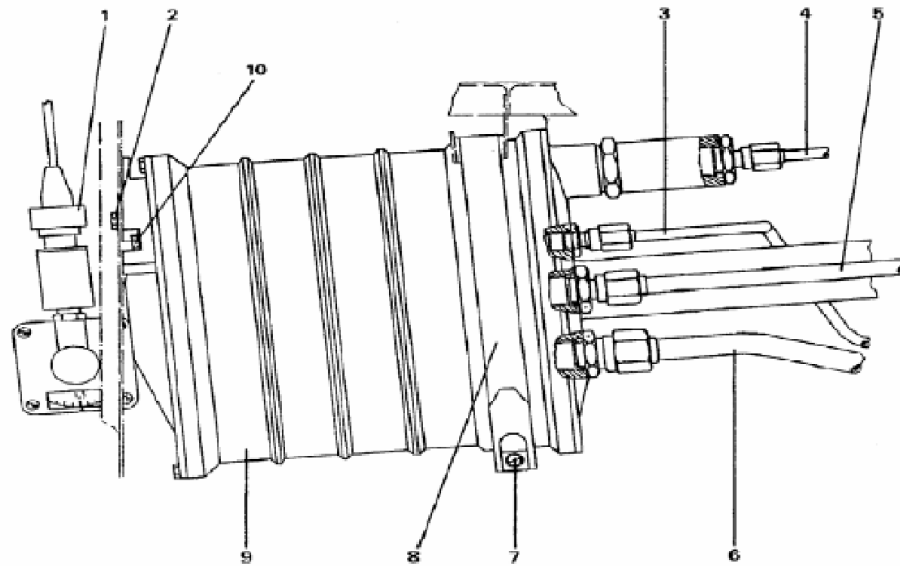

IA63/ DORNIER FAA	
EQUIPMENT SPECIFICATION	SPEC. NO. SL63A--752 500 A01B
	DATE 5.1.1983
	A.T.P. NO.
	PAGES 1-36
Name <u>Hydraulic Reservoir</u>	
Manufacturer <u>Alfred Teves GmbH</u>	Code No. <u>291201</u>
Part. No. <u>6.6216-0000.4</u>	Type _____
DORNIER <u>Otto</u> (Ersteller) Otto, SA20	FMA <u>Arias</u> Arias
<u>Koch</u> (QE) Koch, OE20	<u>Alvarez</u> Alvarez
<u>Rieck</u> Projektleitung Rieck, AP51	<u>Corti</u> Corti
ORIGINAL	
FAA	
14. 05. 85	
ISSUE	A B



MUCHAS GRACIAS